

MVVG[®]

Die Anhängerkupplung.

Anhängerkupplungen
und Elektrosätze
direkt vom Hersteller

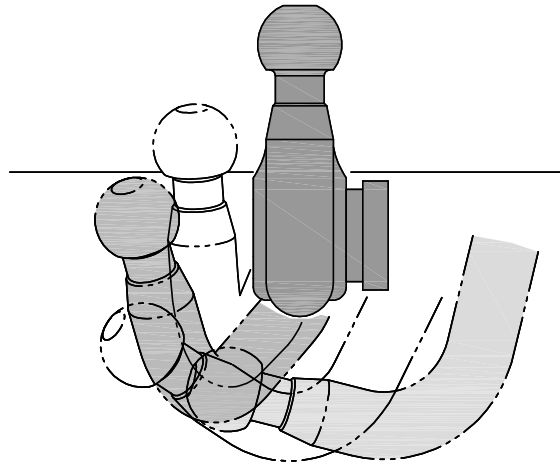

MVVG[®]
schwenkbar[®]

MVVG System: 2080 S

E Instrucciones de manejo

D Bedienungsanleitung

GB Operating Instructions

F Instructions d'emploi

NL Gebruikshandleiding

S Bruksanvisning

CZ Návod k obsluze

I Istruzioni d'uso

An der Wasserwiese 1
D-52249 Eschweiler

E-mail: info@mvg-ahk.de
Internet: www.mvg-ahk.de

Tel.: (02403)7902-60
Fax: (02403)7902-99

Die Bedienungsanleitung als Video finden Sie unter dem folgenden Link:

www.mvg-ahk.de/anleitung2080

Außerdem können Sie mit Ihrem Smartphone den Video-Link durch diesen QR-Code direkt scannen und das Video ansehen.

This instruction manual can be found as an illustrating video under the following link:

www.mvg-ahk.de/anleitung2080

Furthermore, the link to the video can be scanned and watched via this QR code by the use of your smartphone.



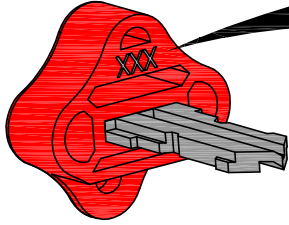
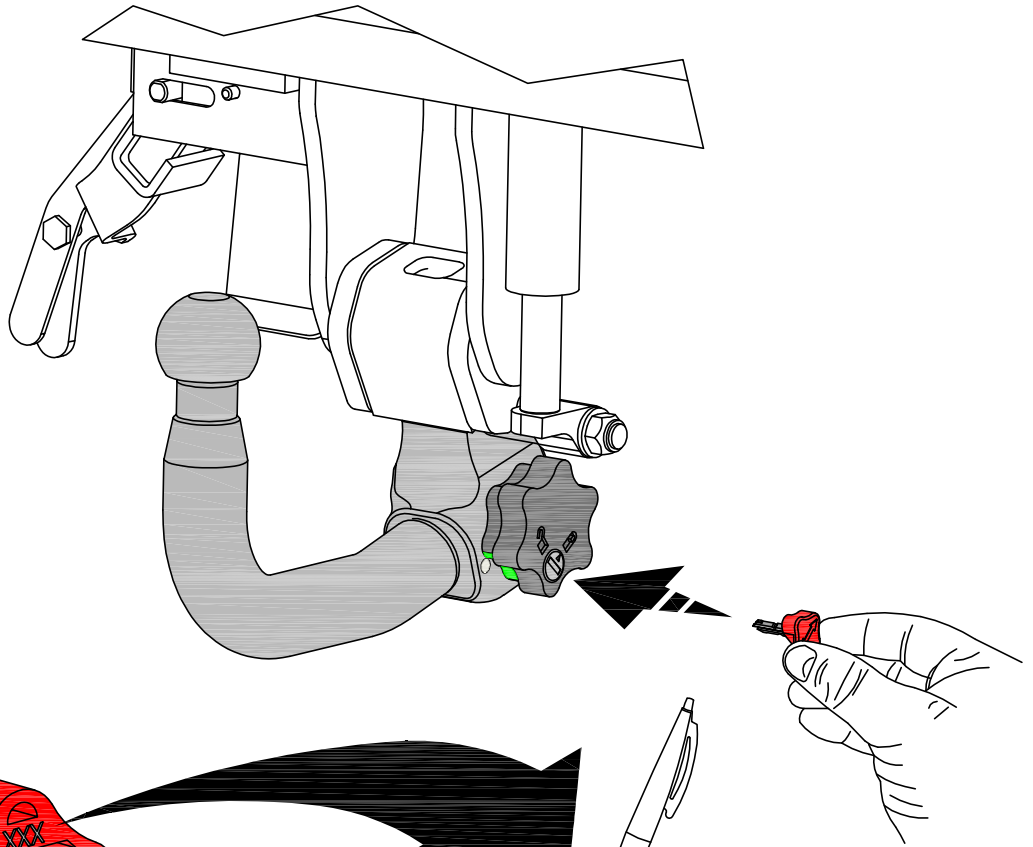

NR.:

1

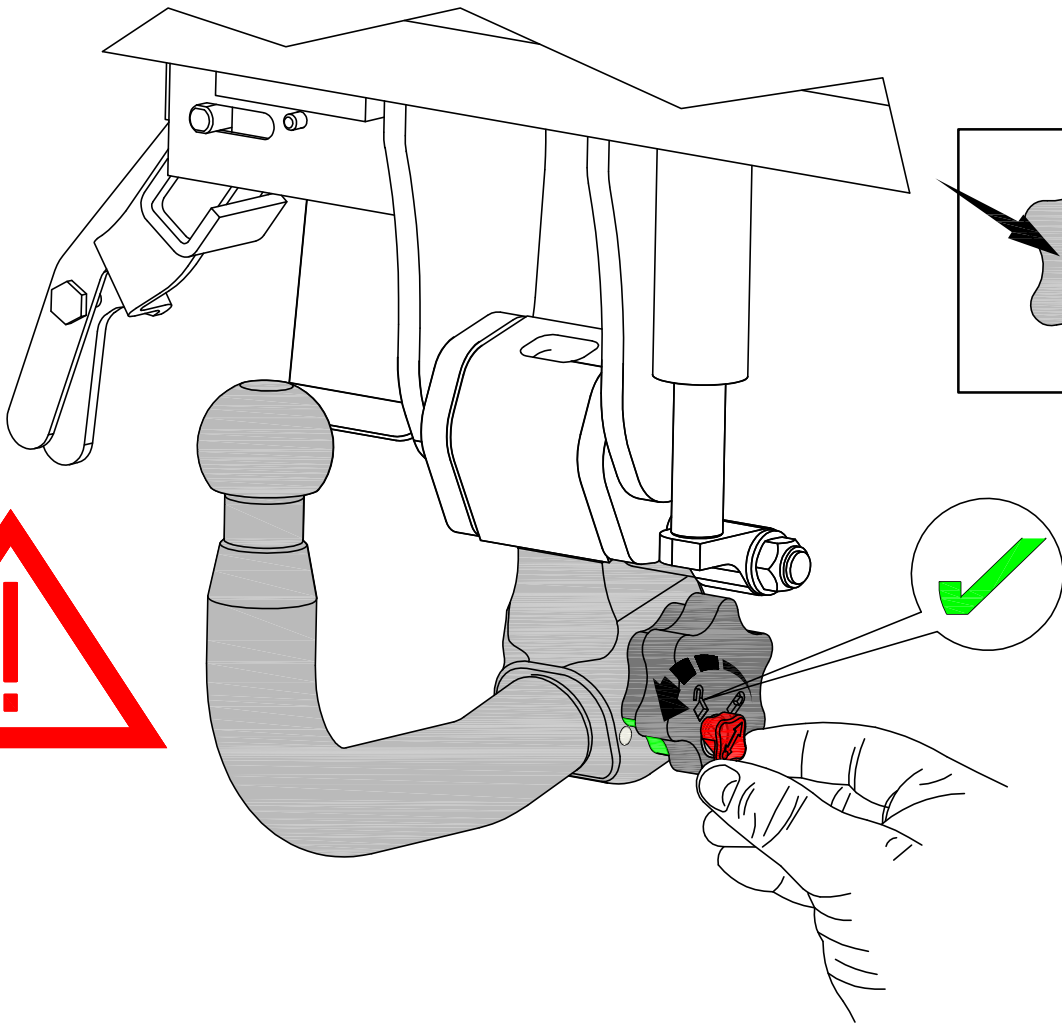
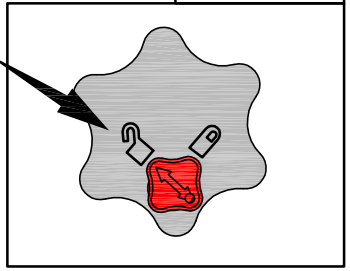
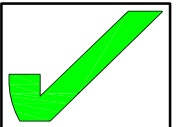

2

1.

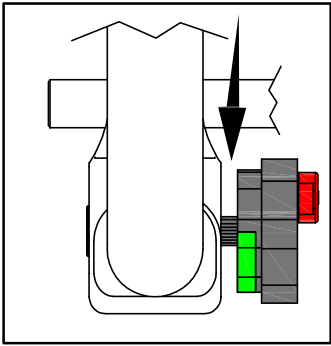
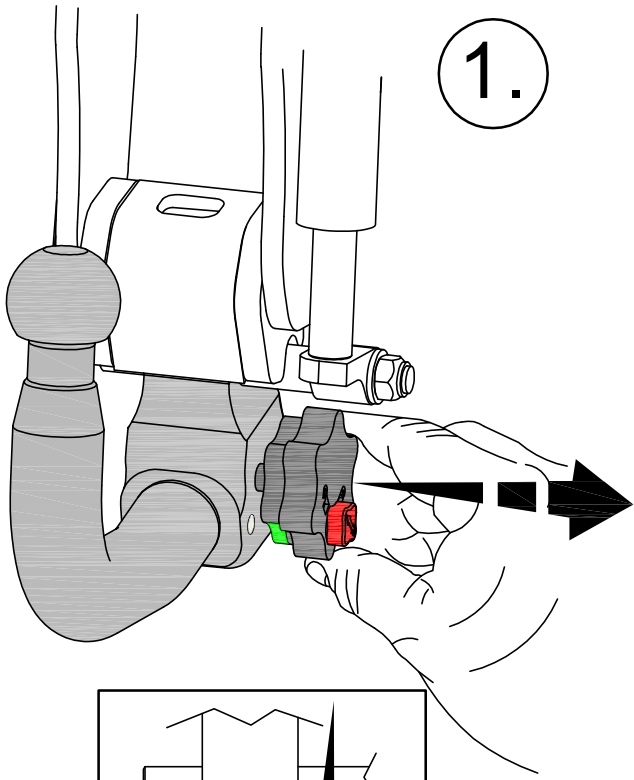

2.

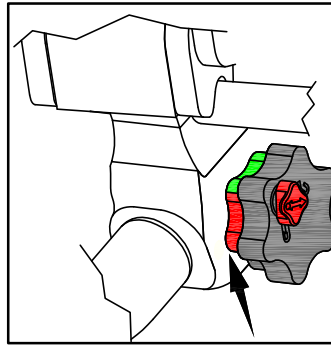
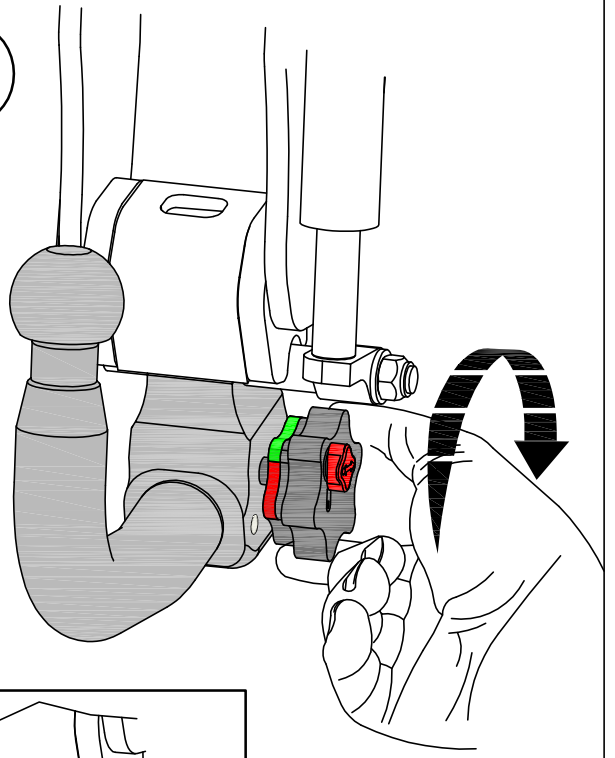

3

3.

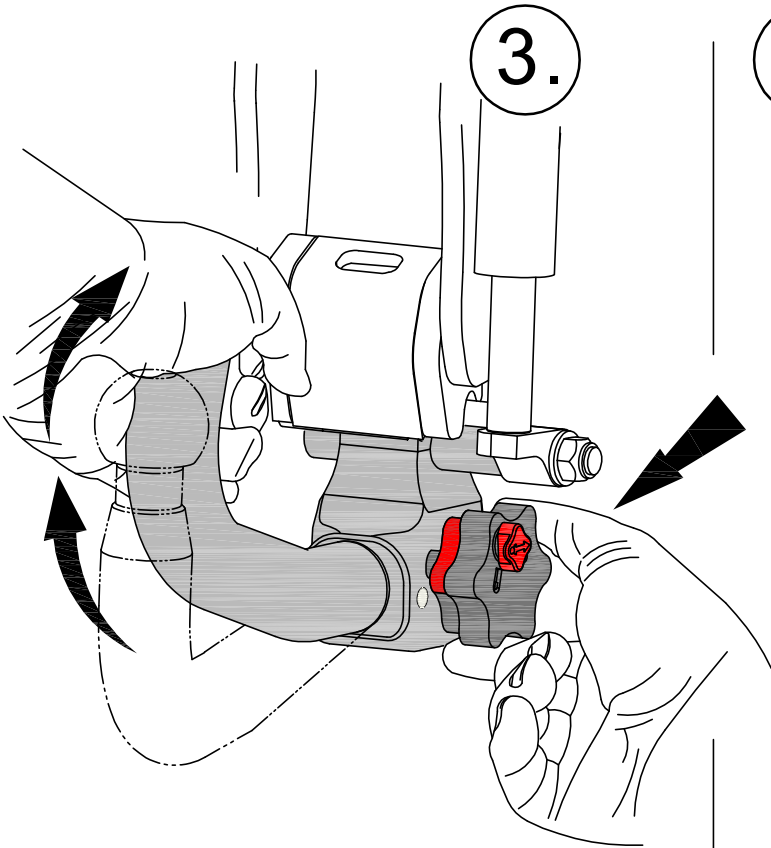

4.

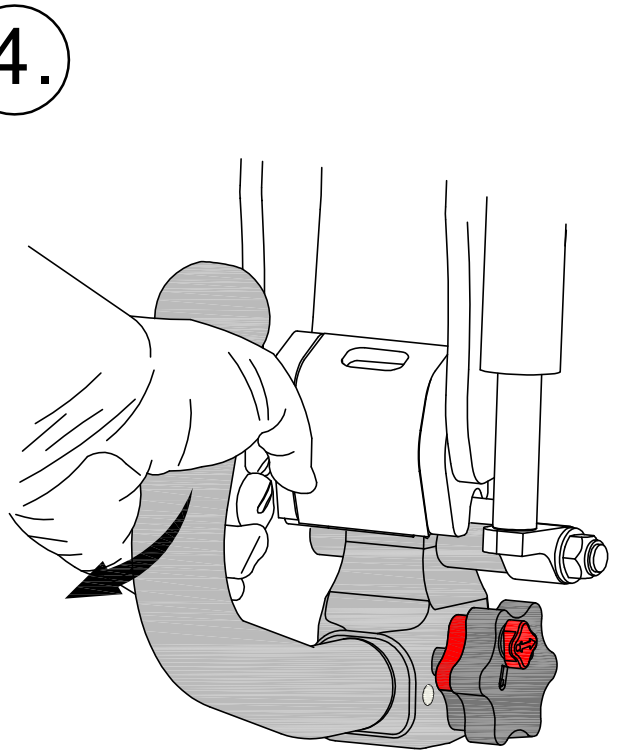

4

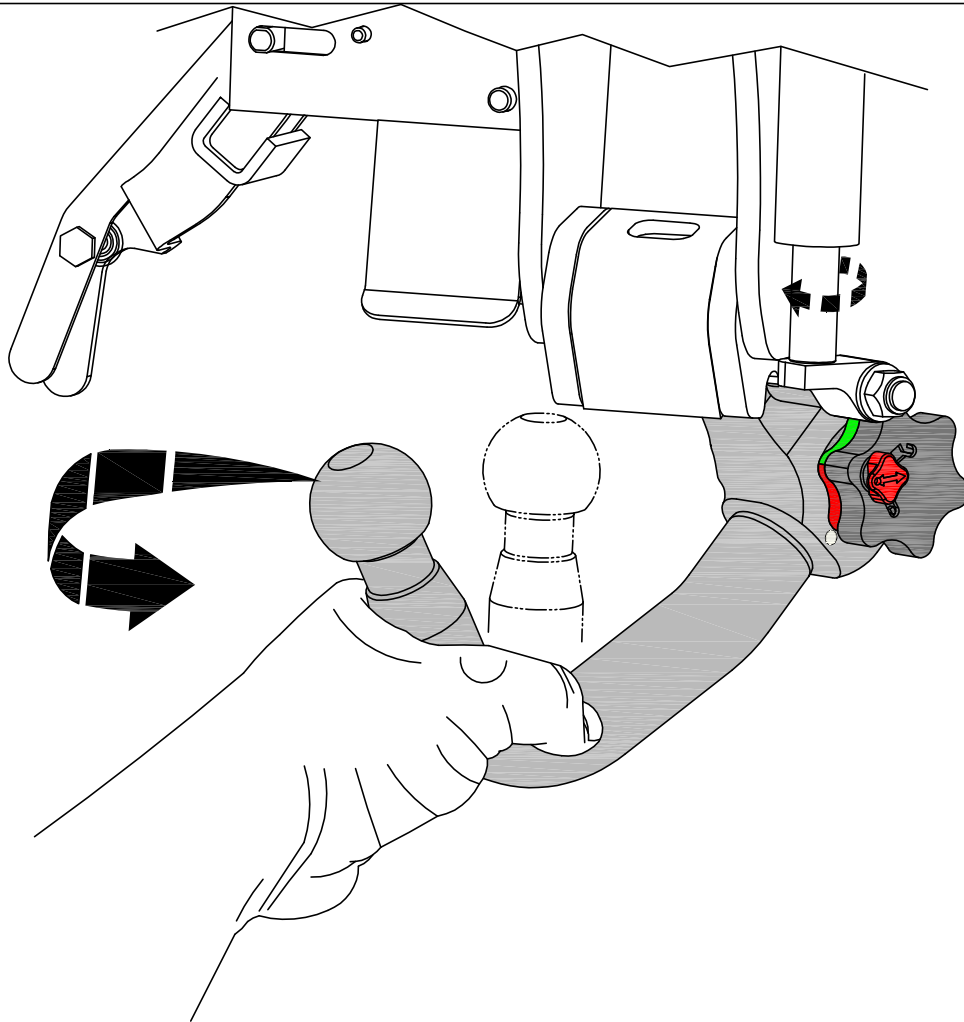

5

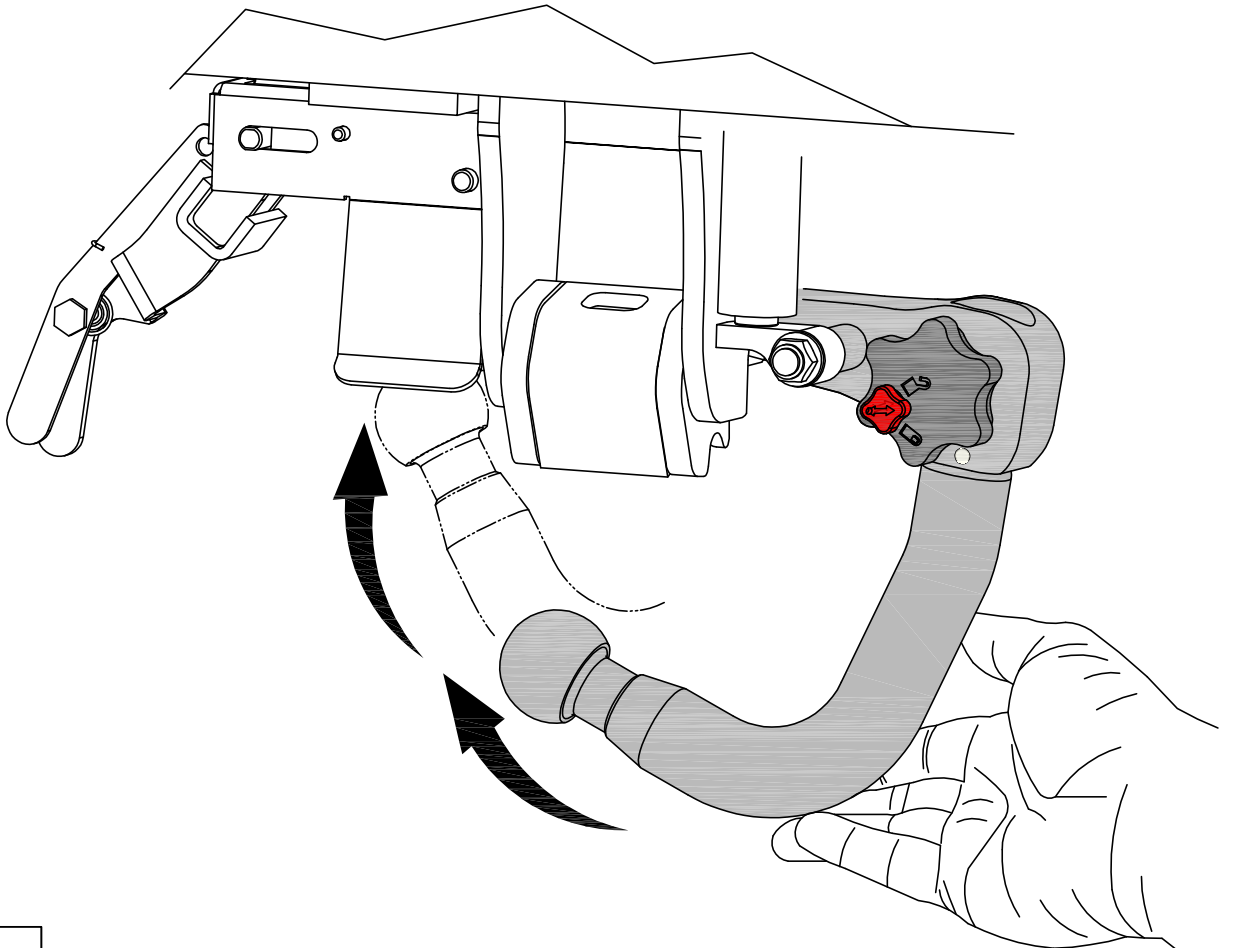

6

Klick

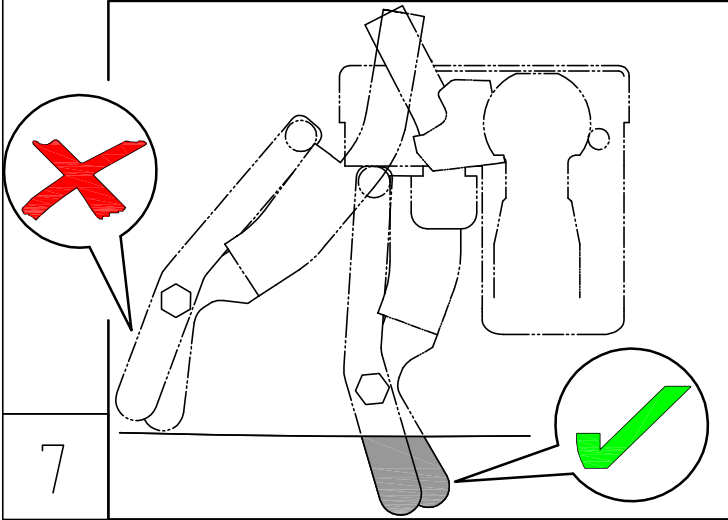
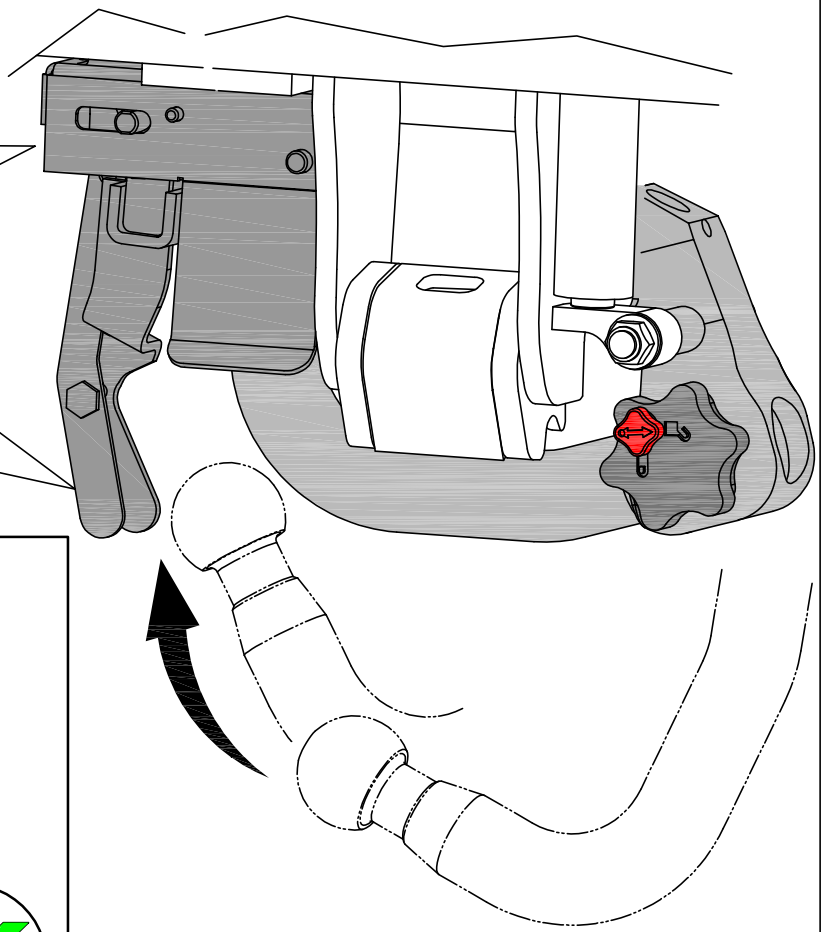
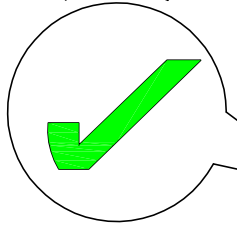
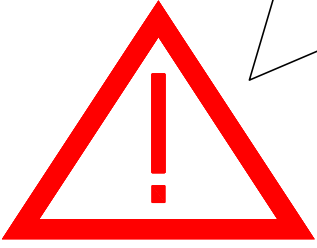

7

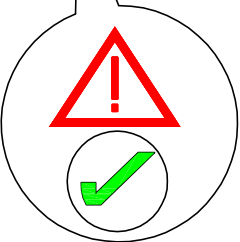
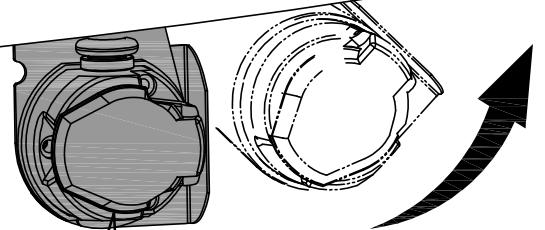
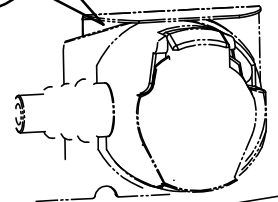
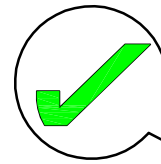
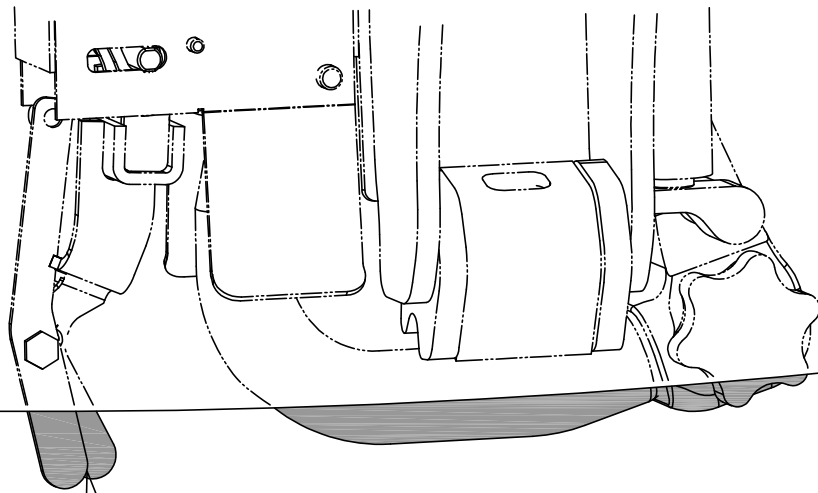

8

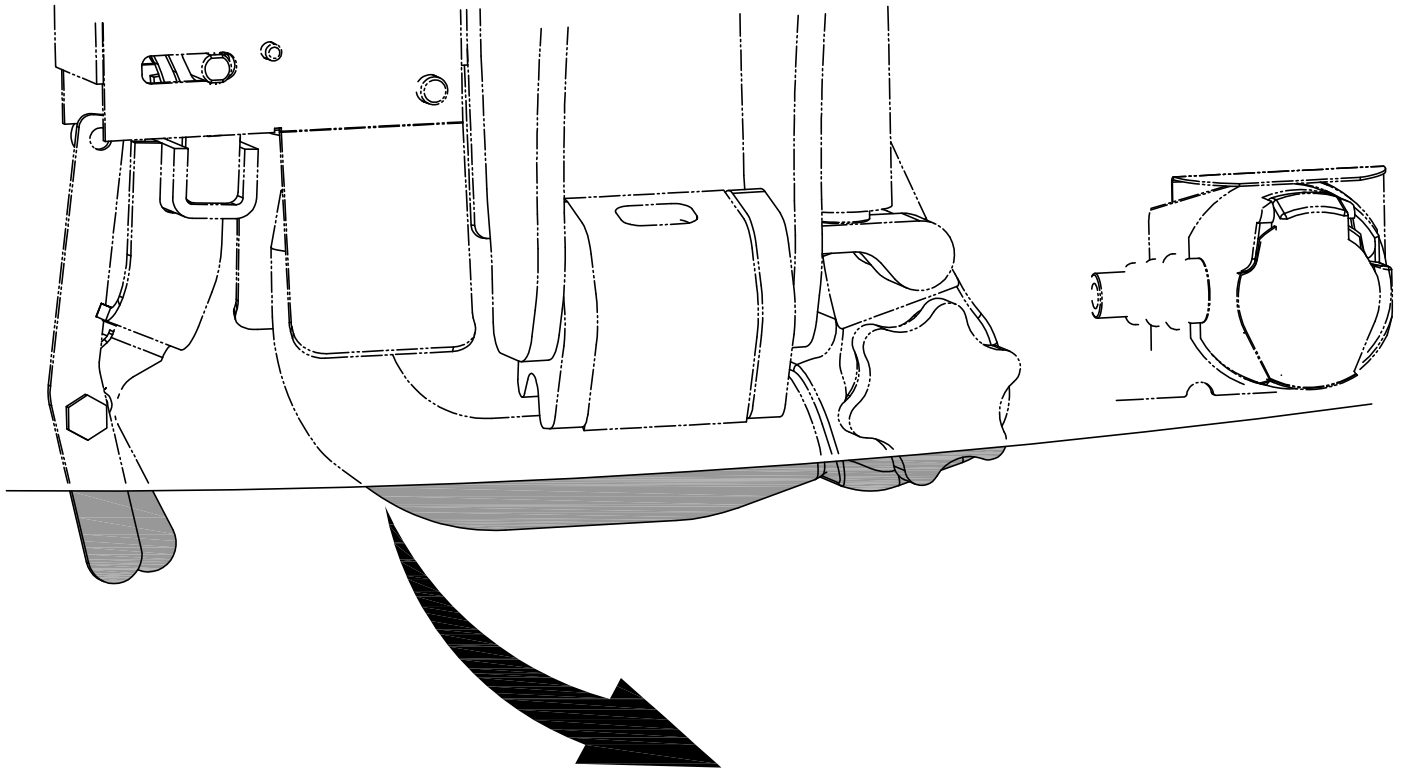

9

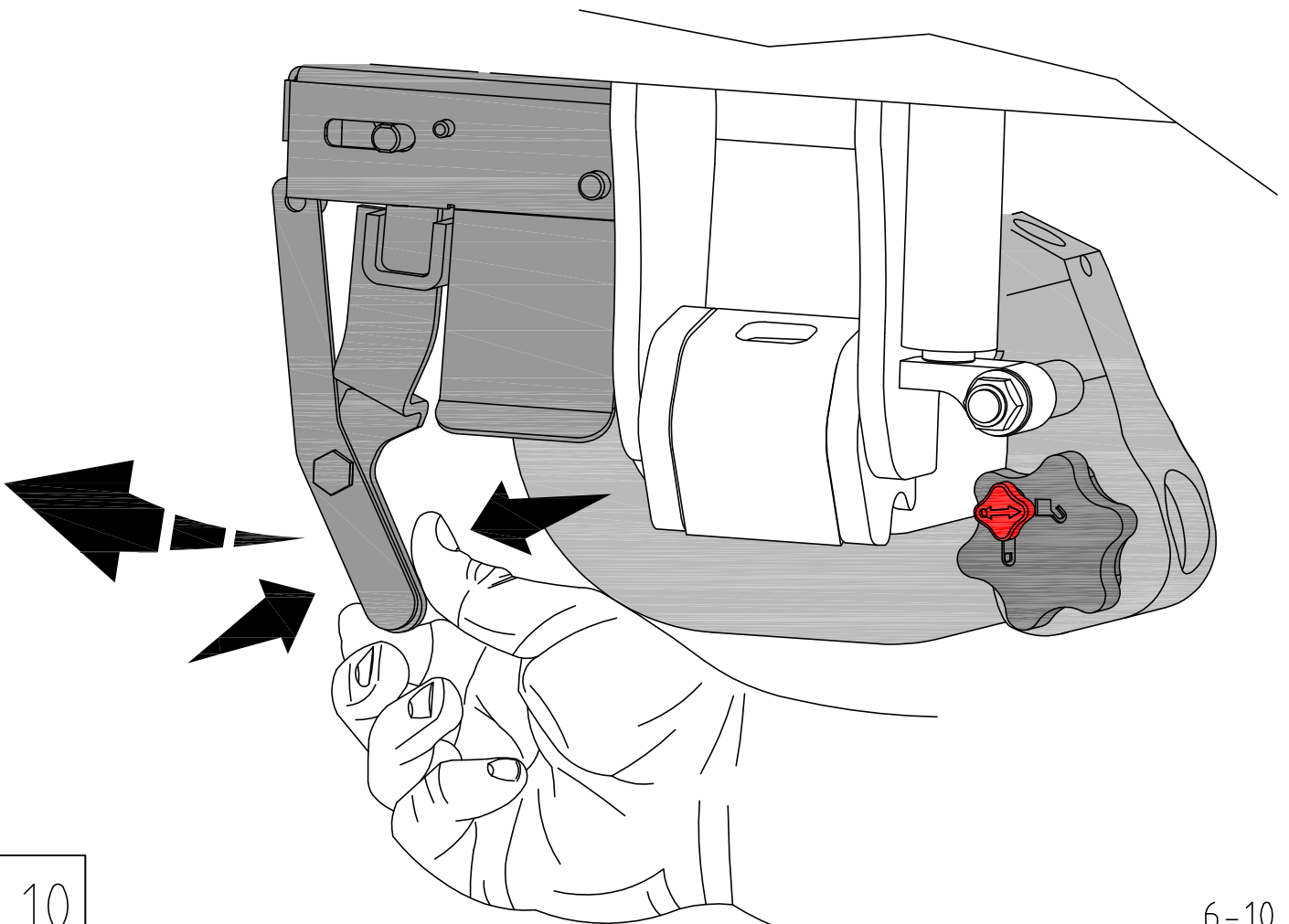

10

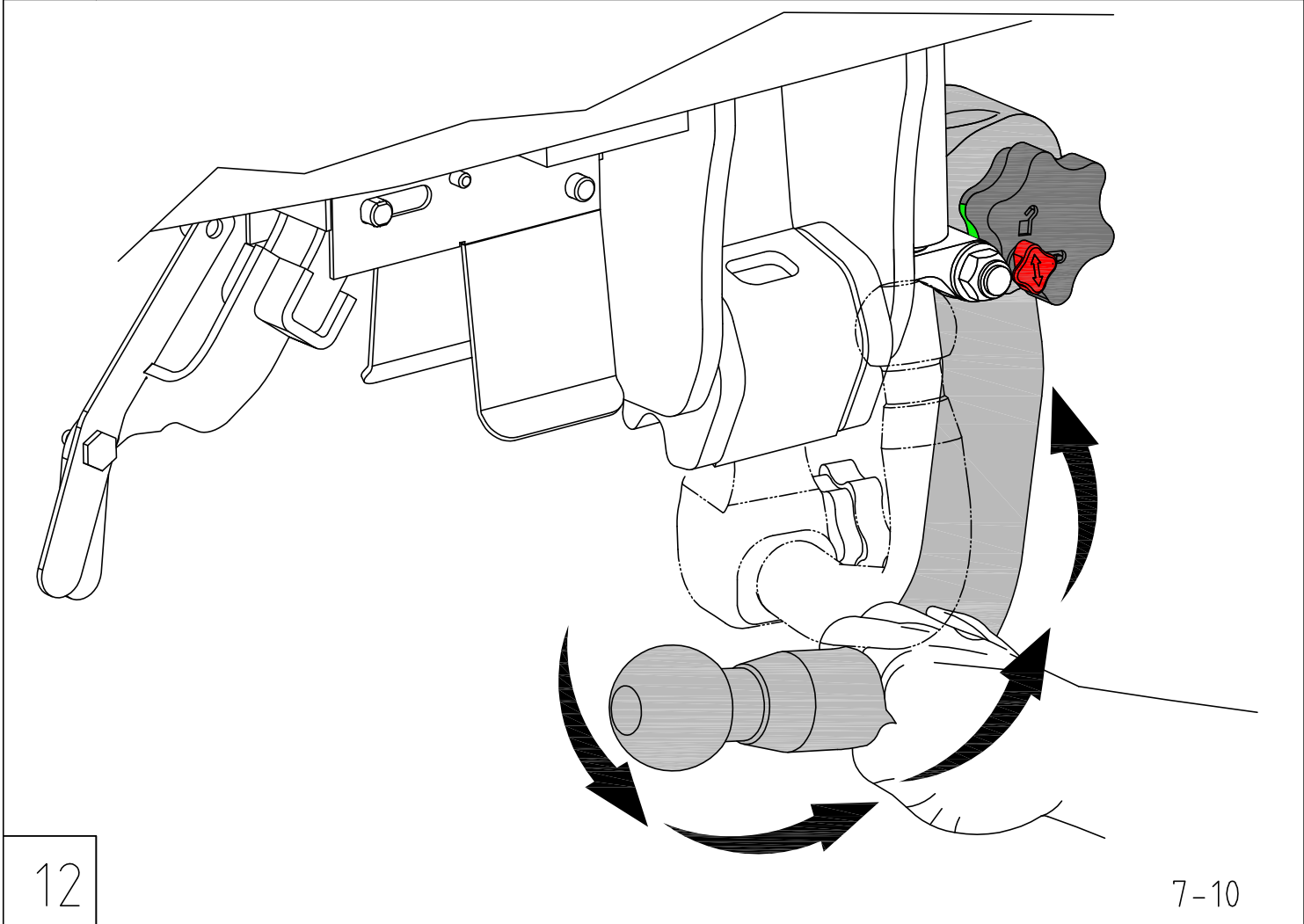
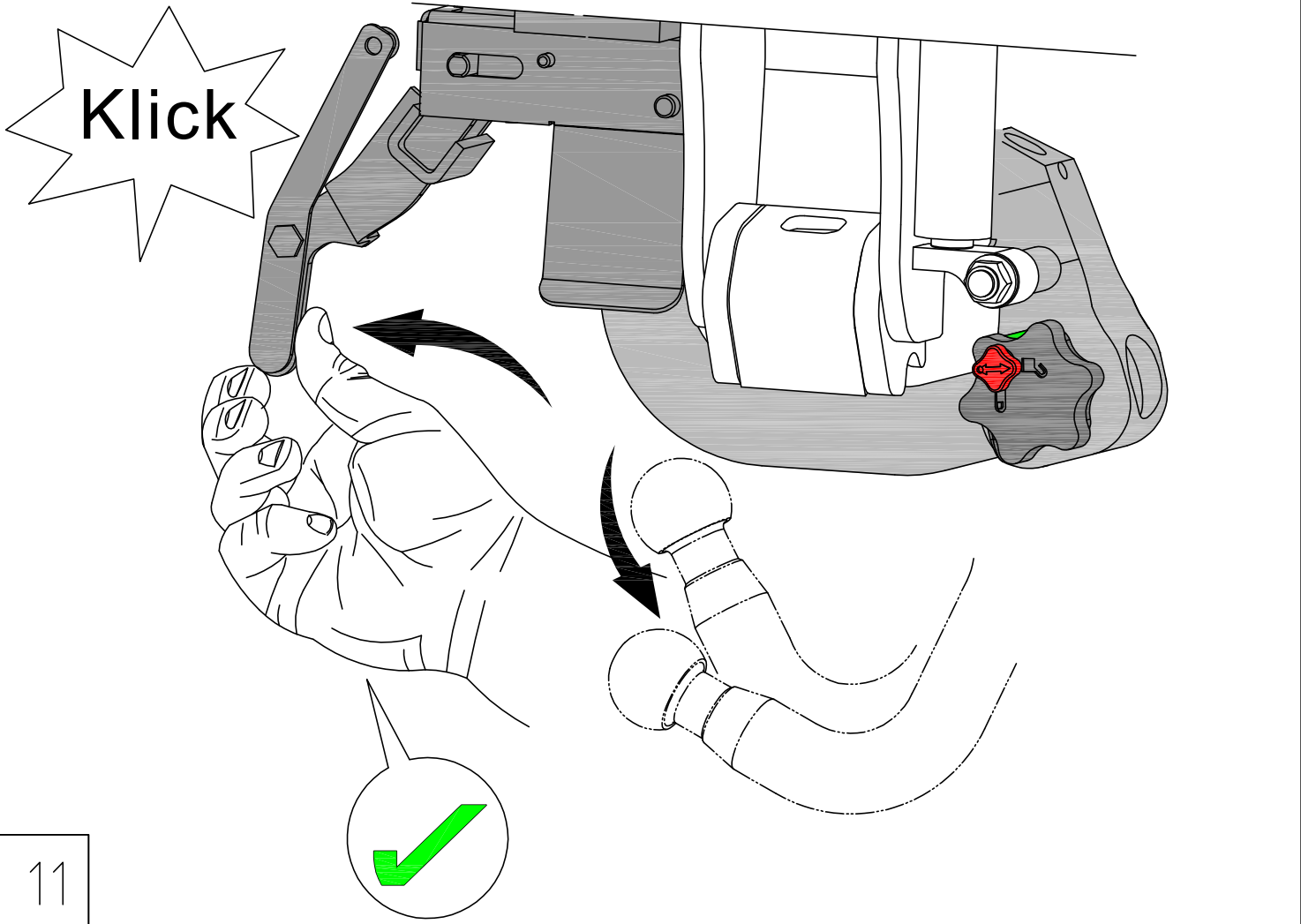

1.

2.

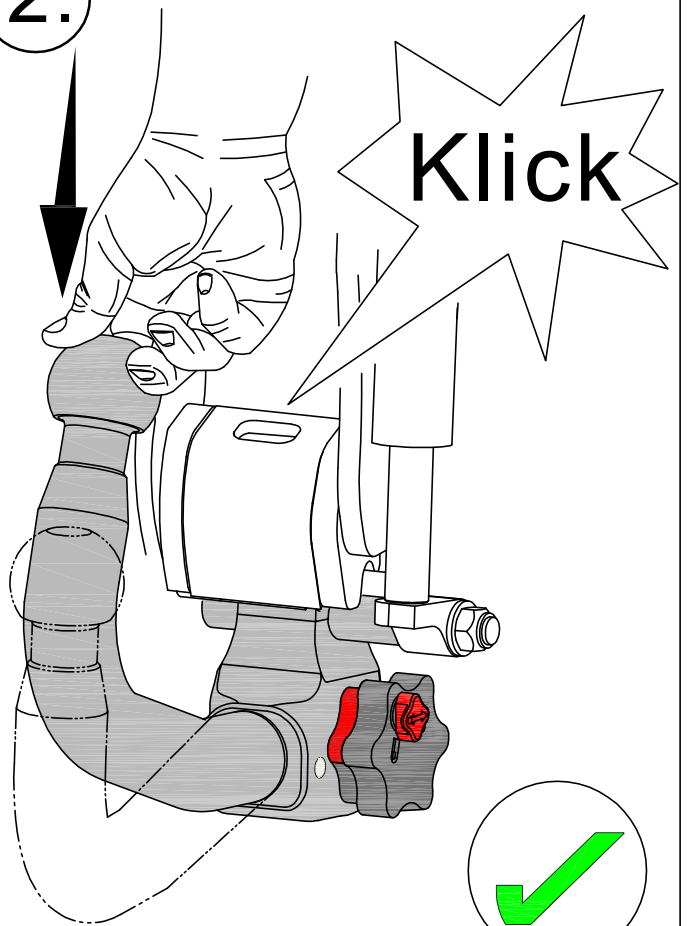
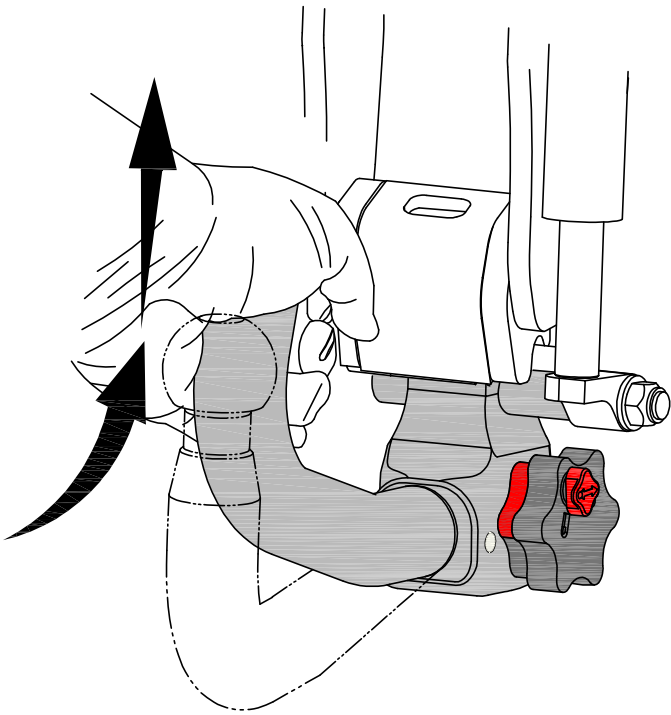

13

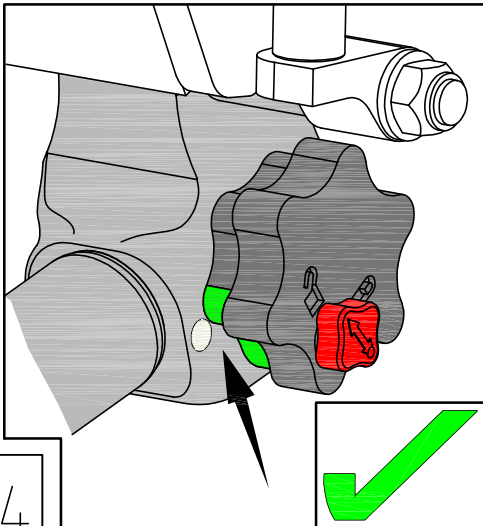
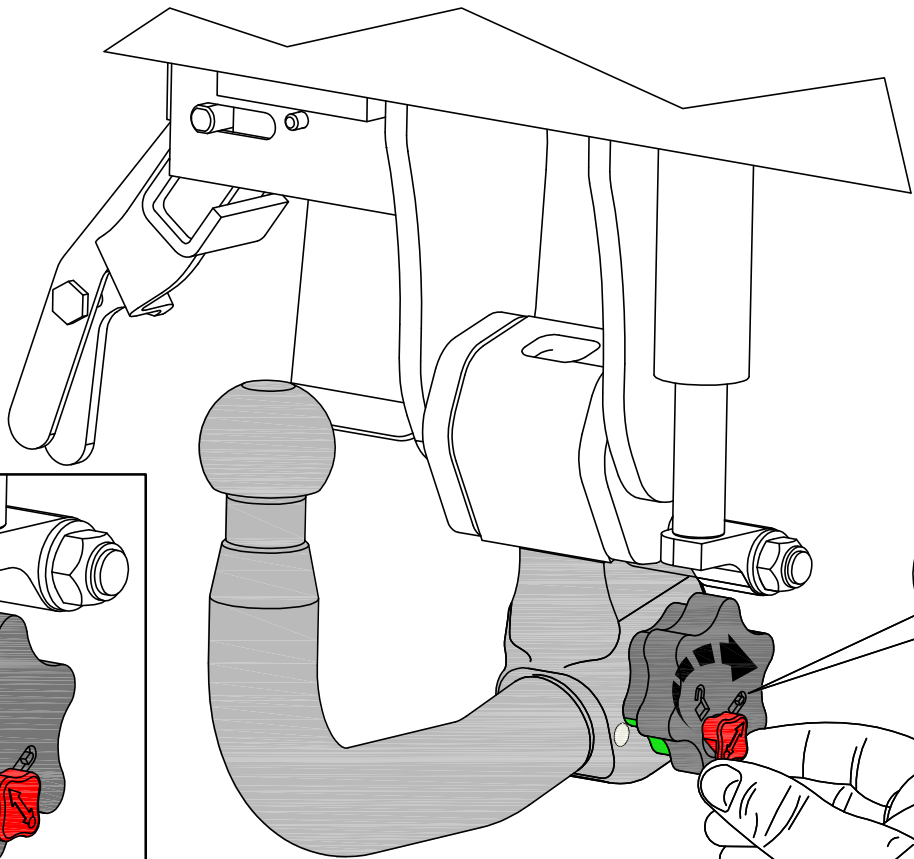

14

8-10

